

D 914

For mobile machinery

43 - 129.9 kW | 57.7 - 174.2 hp at 2300 min⁻¹|rpm

EU Stage IIIA / US EPA Tier 3

- Air-cooled 3 to 6-cylinder naturally aspirated engines in inline arrangement.
- 6-cylinder with turbocharging, charge-air cooled.
- Capacity: 1.1 l/cylinder, modular system with single cylinders.
- The robust engine design allows worldwide operation even with high sulphur fuels.
- Low noise emissions due to acoustically optimized components with very smooth running and high durability.

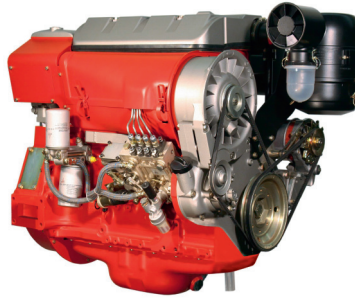

- Highly efficient injection and combustion system ensures optimum engine performance at low consumption.

- Flywheel and end 100% power takeoff possibilities PTO drives for hydraulic pumps and compressor possible, only a few maintenance points, long oil change intervals.
- Very compact engine design reduces the installation costs.
- Best cold starting properties even under extreme conditions.
- The engines in the power range < 56 kW meets to the US EPA Tier 4 i.

Technical data

Engine type		D 914 L3	D 914 L4	D 914 L5
No. of cylinders		3	4	5
Bore/stroke	mm in	102/132 4.0/5.2	102/132 4.0/5.2	102/132 4.0/5.2
Capacity	l cu in	3.2 195	4.3 262	5.4 330
Compression ratio		21:1	21:1	21:1
Nominal speeds	min ⁻¹ rpm	2000 - 2300	2000 - 2300	2000 - 2300
Power output ¹⁾		D 914 L3	D 914 L4	D 914 L5
Power output as per ISO 14396	kW hp	43 58	58 78	72.5 97.2
at speed	min ⁻¹ rpm	2300	2300	2300
Max. torque	Nm lb/ft	204 150.5	273 201.4	337 248.6
at speed	min ⁻¹ rpm	1500	1500	1500
Minimum idling speed	min ⁻¹ rpm	700	700	650 - 700
Specific fuel consumption ²⁾	g/kWh lb/hph	225 0.37	220 0.362	218 0.358
Weight as per DIN 70020 Part 7A ³⁾	kg lb	277 611	307 677	380 838

1) Gross capacity data without deduction of fan capacity

2) Best full load consumption without cooling system refers to diesel with a density of 0.835 kg/dm³ at 15°C | 6.96 lb/US gallon at 60° F.

3) Without starter/dynamo, cooler and fluids but with flywheel and flywheel housing.

The data on this data sheet are for information purposes only and are not binding values. The data in the quotation is definitive.

Torque curve

D 914 L3 - 43 kW|58 hp

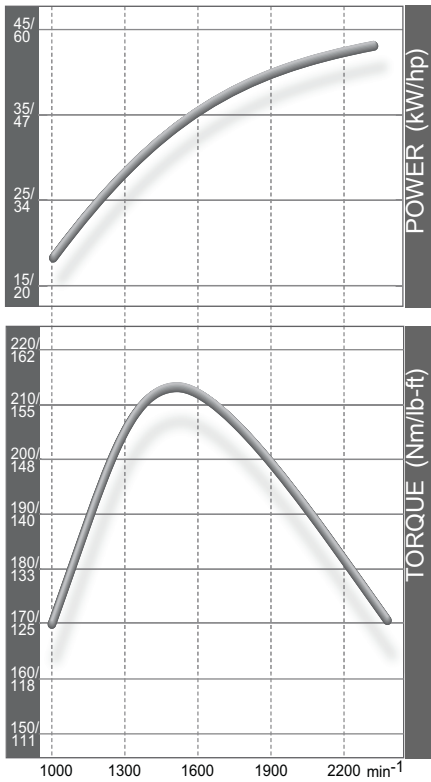

D 914 L4 - 58 kW|78 hp

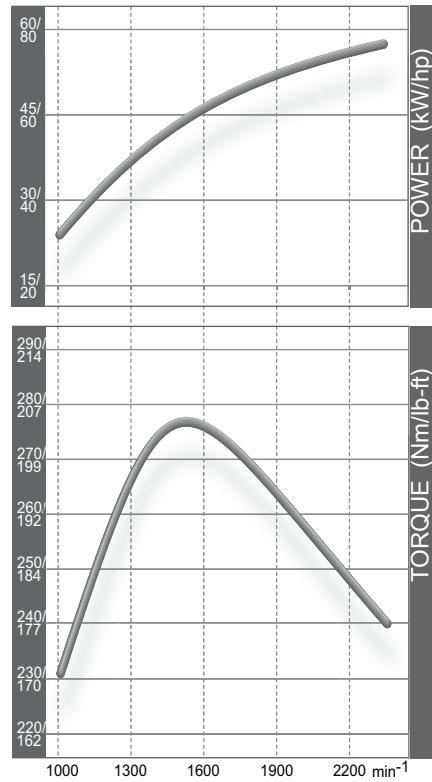

D 914 L5 - 72.5 kW|97.2 hp

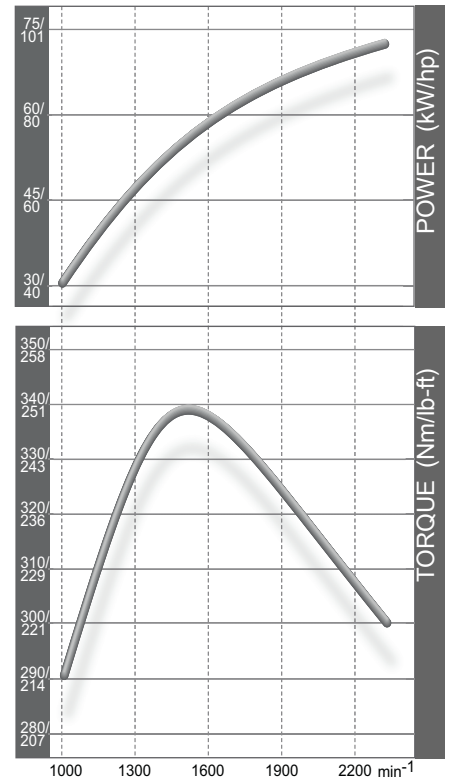

Dimensions

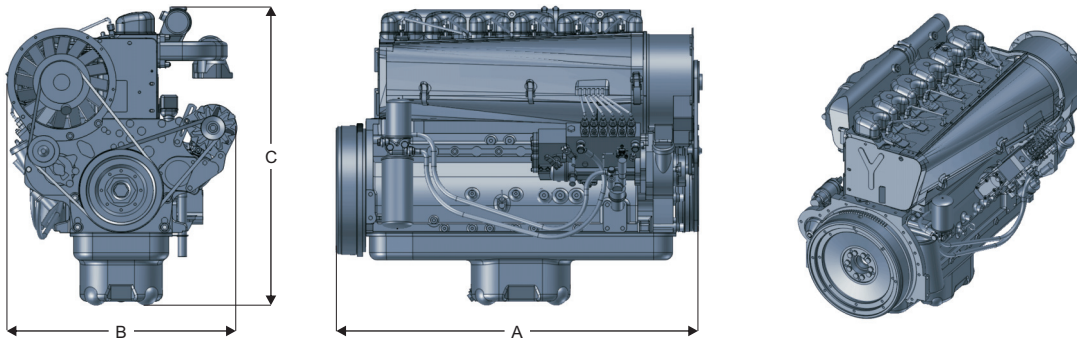

		A	B	C
D 914 L3	mm in	708 27.87	666 26.22	796 31.34
D 914 L4	mm in	838 32.99	666 26.22	800 31.5
D 914 L5	mm in	965 37.99	657 25.87	834 32.83
D 914 L6	mm in	1084 42.68	662 26.06	870 34.25
TCD 914 L6	mm in	1092 42.99	720 28.35	1184 46.61

Note: The engine dimensions and weights vary depending on the scope of delivery.

Technical data

Engine type		D 914 L6	TCD 914 L6
No. of cylinders		6	6
Bore/stroke	mm in	102/132 4.0/5.2	102/132 4.0/5.2
Capacity	l cu in	6.5 397	6.5 397
Compression ratio		21:1	19:1
Nominal speeds	min ⁻¹ rpm	2300	2300
Power output ¹⁾		D 914 L6	TCD 914 L6
Power output as per ISO 14396	kW hp	86.5 116	129.9 174.2
at speed	min ⁻¹ rpm	2300	2300
Max. torque	Nm lb/ft	375 276.6	650 479.4
at speed	min ⁻¹ rpm	1500	1600
Minimum idling speed	min ⁻¹ rpm	650 - 700	650 - 700
Specific fuel consumption ²⁾	g/kWh lb/hph	220 0.362	220 0.362
Weight as per DIN 70020 Part 7A ³⁾	kg lb	420 926	510 1124

1) Gross capacity data without deduction of fan capacity

2) Best full load consumption without cooling system refers to diesel with a density of 0.835 kg/dm³ at 15°C | 6.96 lb/US gallon at 60° F.

3) Without starter/dynamo, cooler and fluids but with flywheel and flywheel housing.

The data on this data sheet are for information purposes only and are not binding values. The data in the quotation is definitive.

Torque curve

D 914 L6 - 86.5 kW|116 hp

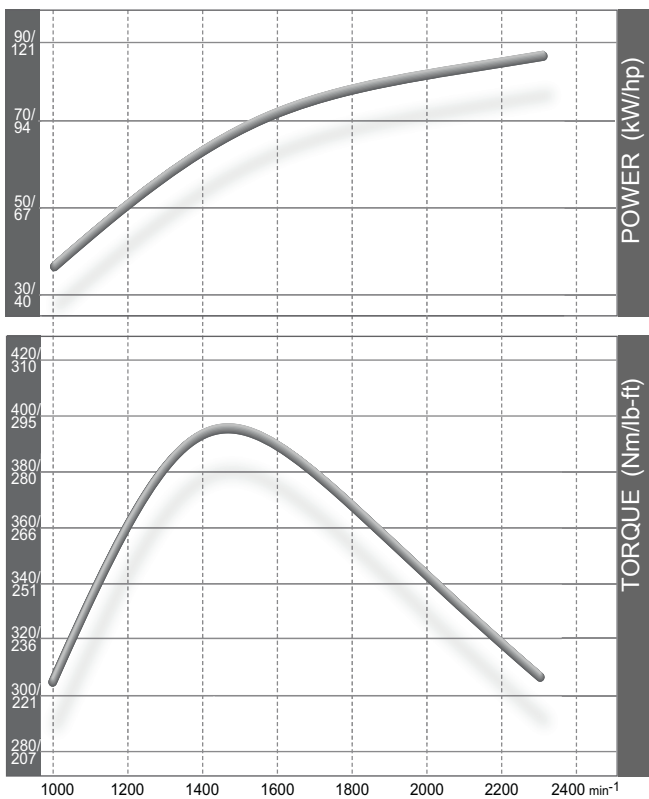

TCD 914 L6 - 129.9 kW|174.2 hp

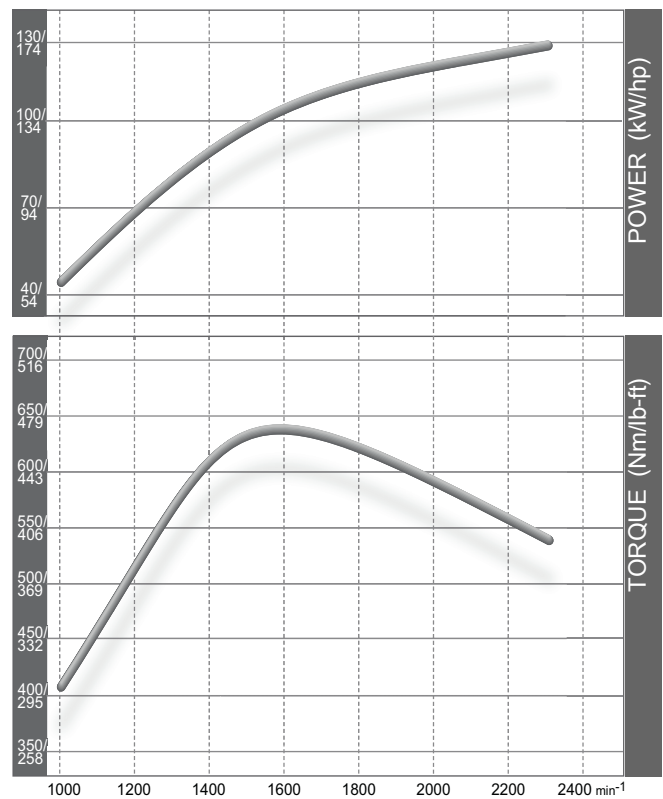

For more information please contact the DEUTZ AG Köln or the responsible sales partner.

